

Department of Engineering  
Tim Bryan, P.E., County Engineer

3137 South Liberty Street, Canton, MS 39046  
Office (601) 790-2525 FAX (601) 859-3430

MEMORANDUM

June 20, 2023

To: Sheila Jones, Supervisor, District I  
Trey Baxter, Supervisor, District II  
Gerald Steen, Supervisor, District III  
Karl Banks, Supervisor, District IV  
Paul Griffin, Supervisor, District V

From: Tim Bryan, P.E., PTOE  
County Engineer

Re: Comcast Cable Utility Permit  
County Road Name, Pat Lockett Road and Grown Williams Road

The Engineering Department recommends approval of the permit application for Comcast Cable is attaching 48 CT and 24 CT fiber to existing poles, boring and installing 2" HDPE to pull 48 CT and 24 CT fiber within the right-of-way owned by the County including the listed roads below.

- Pat Lockett Road
- and Grown Williams Road

Revised: 2/14/2019



**PERMIT APPLICATION FOR THE CONSTRUCTION OR ADJUSTMENT OF A UTILITY WITHIN COUNTY ROAD RIGHT-OF-WAY**

Utility Information: Utility Name: COMCAST CABLE

Address: 3425 Malone Drive City/State/Zip: Chamblee/ GA/ 30-341

Contact Person: Linda Taibl Contact's Phone: \_\_\_\_\_

Project Information: County Road Name: \_\_\_\_\_  
(If located within more than one road right-of-way, use Appendix 1 for additional descriptions)

Beginning Location: 32.670399, -89.767953 Ending Location: 32.653022, -89.793853

Length of Project: 10 438 FT Section: 34 Township: 3 Range: 69

Description of Work: COMCAST IS ATTACHING 48CT AND 24 CT FIBER TO EXISTING POLES, BORING AND INSTALLING 2" HDPE TO PULL 48CT AND 24CT FIBER WITHIN THE RIGHT-OF-WAY OWNED BY THE COUNTY.

**TOTAL INSTALLATION LENGTH IN ROW: 10 438 FT**

Check Box if Appendix 1 is to be included as a part of this Application

Whereas the above stated Utility makes application to the **Madison County Board of Supervisors** for a Construction Permit. Attached hereto are drawings and plans for the construction of the above facilities located within Madison County owned public rights-of-way. Once stamped by the Madison County Engineering Department, these plans shall not be changed or altered without written approval of the County Engineer, or his representative. A copy of the approved permit and plans shall be on-site at all times during construction.

The Applicant Utility shall comply with all policies, procedures and construction practices as outlined in *A Policy for The Accommodation of Utility Facilities within the Right-of-Way of all Public County Roads* (hereinafter referred to as the "Policy"), as adopted on November 1, 2005, by the **Madison County Board of Supervisors**, and which is hereby made a part of this Application Agreement.

If facilities are to be located within the Rights-of-Way of the County-Federal or State Aid System, Applicant Utility also agrees to comply with applicable provisions of *S.O.P. No. SA II-2-8, Accommodation of Utilities on Rights-of-Way*, issued by the State Aid Engineer and dated July 1, 2005.

The Applicant Utility understands and agrees that, except as herein granted, no right, title, claim, or easement to said road right-of-way is granted by the issuance of this permit. If this Utility is listed in the general provisions of the Policy, it will be adjusted to comply with same without cost to the County, unless the variance from the Policy has been approved by the granting of the Permit pursuant to this Application.

The Applicant Utility further understands that the Utility's engineering, plant, or other personnel will be responsible for the staking and construction supervision of the work set out above and as shown on the attached plans. If work impacts traffic in any way, the appropriate traffic control shall be installed per the *Manual of Uniform Traffic Control Devices*, Latest Edition.

The Applicant Utility understands that the County Engineer, or his representative, may issue a Stop Work Order at any time if it is deemed that site conditions are not suitable for construction or if any of the requirements of this permit are not being met.

Many County Roads have variable Rights-of-Way and/or no Right-of-Way at all and are maintained under a Prescriptive Easement. It is the sole responsibility of the Applicant Utility to verify the existence and limits of public rights-of-way. If none exists, it is the

responsibility of the Applicant Utility to acquire an easement for their Facilities from the applicable property owner(s). Madison County in no way verifies the limits of Right-of-Way as shown on the permit application.

The Applicant Utility shall be responsible for all future maintenance and repair of the facilities installed under this permit. The Applicant Utility shall make future adjustments to, or relocate, the facilities located within road or highway right-of-way when required for road or highway widening or other road or highway construction at no cost to Madison County. The Applicant Utility shall relocate said utilities within sixty (60) days of notification by County by registered mail, return receipt requested, unless otherwise designated by the County Engineer. Further, any maintenance, repair, or construction shall be done in such a manner as to occasion no unreasonable interference with the normal flow and safety to traffic and at the expense of the utility company. When reasonable care has been taken to locate said utility facilities within the right-of-way, the Applicant Utility understands that any damages caused by routine maintenance and construction by County forces shall be borne by the Applicant Utility.

The Applicant Utility further agrees to indemnify and hold Madison County harmless for any and all claims, accidents, damages, liabilities and expenses occasioned wholly, or in part, by any act or omission of applicant, its agents or employees. In case County shall, without fault on its own part, be made a party to any litigation commenced by or against applicant, then applicant shall protect and hold County harmless, and shall pay all costs, expenses and reasonable attorney's fees incurred or paid by County in connection with said litigation.

All underground facilities shall be installed at a depth equal to or greater than 48" below the lowest adjacent grade.

All pipes carrying liquid shall be encased under County maintained roads.

WITNESS the signature of the Applicant this the 15 day of 06, 2023.

By: Linda Taibl  
(Applicant Signature)

Title: Construction specialist

**Note:** Applicant must be an employee of the Utility named in this application. The Madison County Board of Supervisors will not recognize a Contractor, Subcontractor, Agent, or Consulting Engineer as the Applicant. Utility Company shall be fully responsible for all work performed under this application.

I, or my authorized representative, have reviewed this application and determined that the drawing, sketches, and plans submitted by the Applicant meet the requirements of A Policy for The Accommodation of Utility Facilities within the Right-of-Way of all Public County Roads.

**APPROVED**  
By timothy.bryan at 12:43 pm, Jun 27, 2023

By: Tim Bryan, P.E.  
County Engineer **BJ**

AGREED TO AND APPROVED BY:

\_\_\_\_\_  
Madison County Board President

Date: \_\_\_\_\_

ENTERED INTO THE MINUTES OF THE BOARD OF SUPERVISORS OF MADISON COUNTY, MISSISSIPPI ON THIS \_\_\_\_\_ DAY OF \_\_\_\_\_, 20\_\_\_\_.

Appendix 1

County Road Name: PAT LUCKETT RD  
Beginning Location: 32.670399, -89.767953 Ending Location: 32.653022, -89.793853  
Length of Project: 10 301 FT Section: 34 Township: 3 Range: 69  
Description of Work: ATTACH 48CT AND 24 CT FIBER TO EXISTING POLES, BORE AND  
INSTALL 2" HDPE TO PULL 48CT AND 24CT FIBER WITHIN THE PAT LUCKETT RD RIGHT-OF-WAY

County Road Name: GROWN WILLIAMS RD  
Beginning Location: 32.662592, -89.780439 Ending Location: 32.662453, -89.780748  
Length of Project: 137 FT Section: 34 Township: 3 Range: 69  
Description of Work: ATTACH 24 CT FIBER TO EXISTING POLES, BORE AND  
INSTALL 2" HDPE TO PULL 24CT FIBER WITHIN THE GROWN WILLIAMS RD RIGHT-OF-WAY

County Road Name: \_\_\_\_\_  
Beginning Location: \_\_\_\_\_ Ending Location: \_\_\_\_\_  
Length of Project: \_\_\_\_\_ Section: \_\_\_\_\_ Township: \_\_\_\_\_ Range: \_\_\_\_\_  
Description of Work: \_\_\_\_\_

County Road Name: \_\_\_\_\_  
Beginning Location: \_\_\_\_\_ Ending Location: \_\_\_\_\_  
Length of Project: \_\_\_\_\_ Section: \_\_\_\_\_ Township: \_\_\_\_\_ Range: \_\_\_\_\_  
Description of Work: \_\_\_\_\_

County Road Name: \_\_\_\_\_  
Beginning Location: \_\_\_\_\_ Ending Location: \_\_\_\_\_  
Length of Project: \_\_\_\_\_ Section: \_\_\_\_\_ Township: \_\_\_\_\_ Range: \_\_\_\_\_  
Description of Work: \_\_\_\_\_



PREPARED BY:



QUASAR, INC.

COMCAST IS ATTACHING FIBER TO EXISTING  
POLES, BORING AND INSTALLING NEW CONDUIT WITHIN  
THE RIGHT-OF-WAY OWNED BY THE COUNTY.  
TOTAL: 10438 ft

NO SCALE

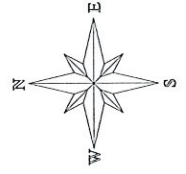

ENGINEERED FOR:



COMCAST

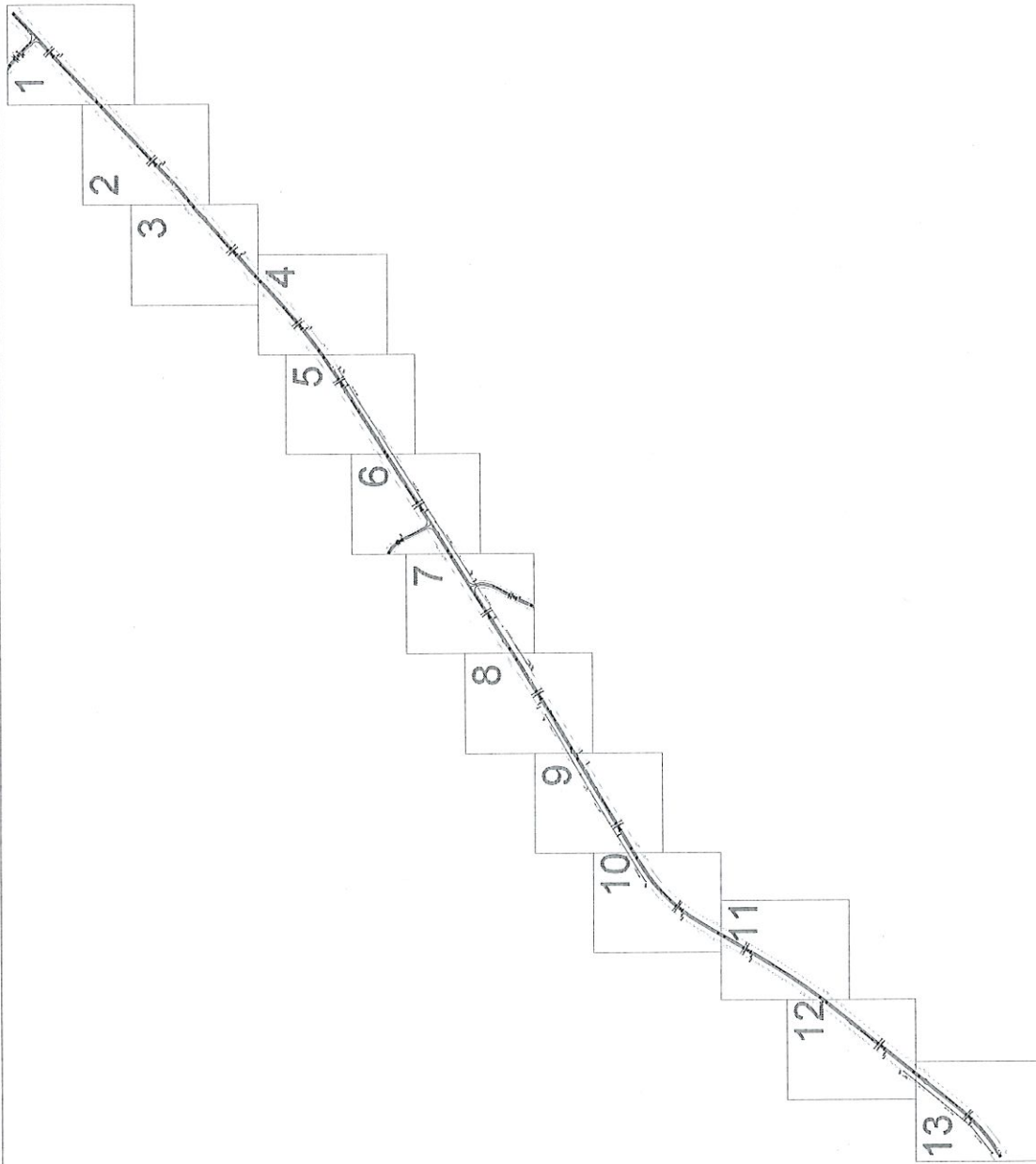

ENGINEERED FOR:



COMCAST

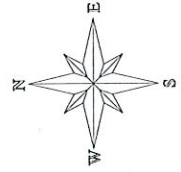

COMCAST IS ATTACHING FIBER TO EXISTING  
 POLES, BORING AND INSTALLING NEW CONDUIT WITHIN  
 THE RIGHT-OF-WAY OWNED BY THE COUNTY.  
 TOTAL: 10438 ft

NO SCALE

PREPARED BY:



QUASAR, INC.

NO MATCH SHEET

NO MATCH SHEET

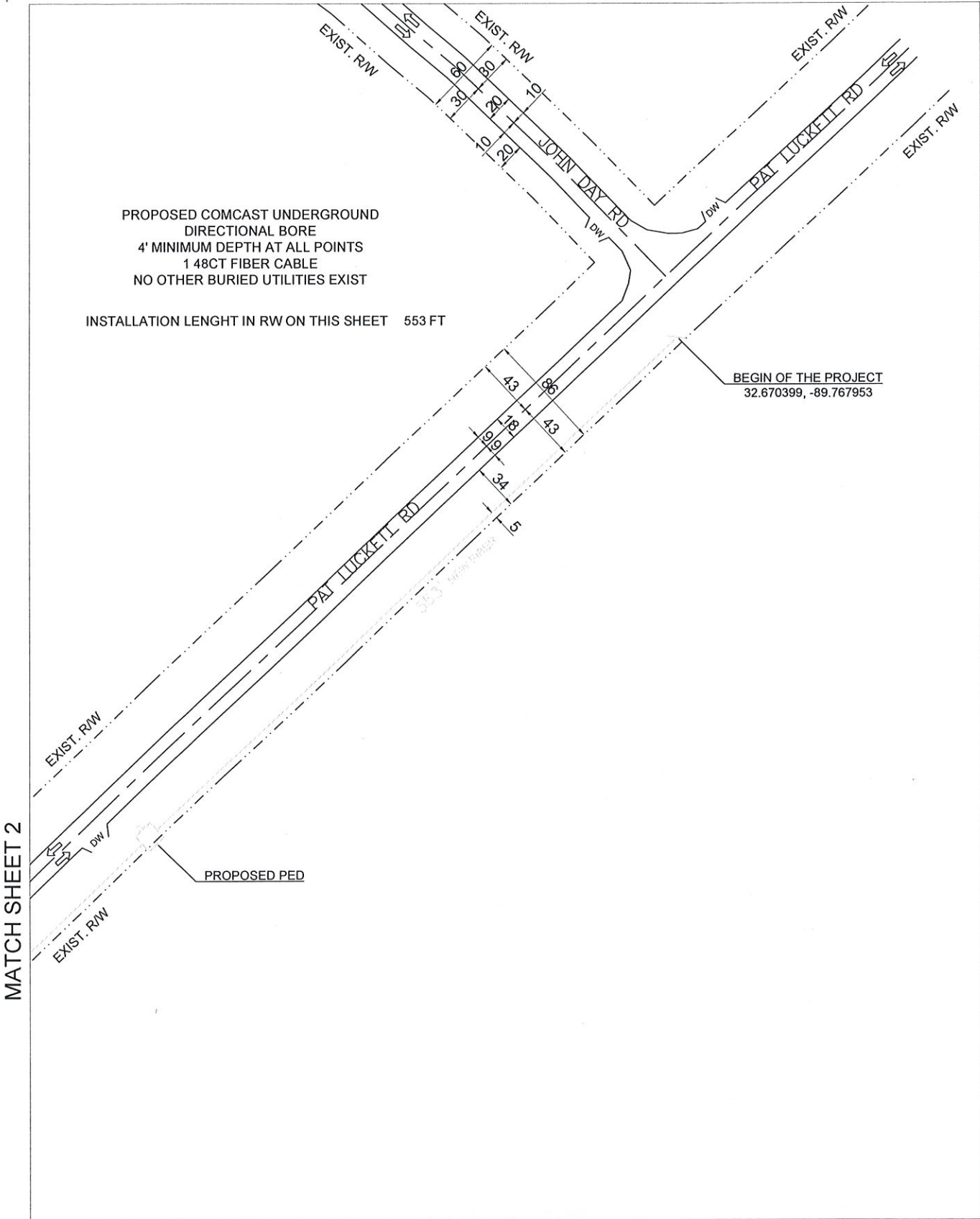

MATCH SHEET 2

NO MATCH SHEET

PREPARED BY:  	EXISTING POLE PROPOSED PEDESTAL PROPOSED VAULT WATER VALVE FIBER MARKER GAS MARKER MANHOLE SEWER MANHOLE STORM DRAIN	RIGHT OF WAY LINE IRRIGATION LINE WATER LANE GAS LANE PROPOSED ANCHOR PROPOSED RISER  <b>LEGEND:</b> RW - RIGHT OF WAY EOP - EDGE OF PAVEMENT DW - DRIVEWAY PDM - PAVED DRIVEWAY	PROPOSED COAXIAL CABLE PROPOSED FIBER CABLE PROPOSED DIRECTIONAL BORE EXISTING CABLE		ENGINEERED FOR:  	MADISON COUNTY  PAT LUCKETT RD  TRANSPORT FIBER
	NOTES: BORE HOLE TO BE FILLED SAME DAY VAULT HOLE TO BE FILLED SAME DAY ALL HOLE TO BE TAMPED AND SODDED	NO SCALE SHEET 1 OF 13				

NO MATCH SHEET

MATCH SHEET 1

PROPOSED COMCAST UNDERGROUND  
DIRECTIONAL BORE  
4' MINIMUM DEPTH AT ALL POINTS  
1 48CT FIBER CABLE  
NO OTHER BURIED UTILITIES EXIST

INSTALLATION LENGTH IN RW ON THIS SHEET 894 FT

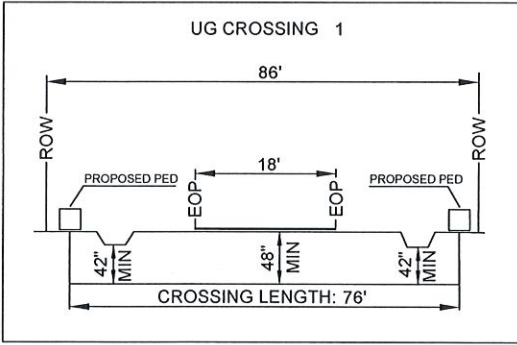
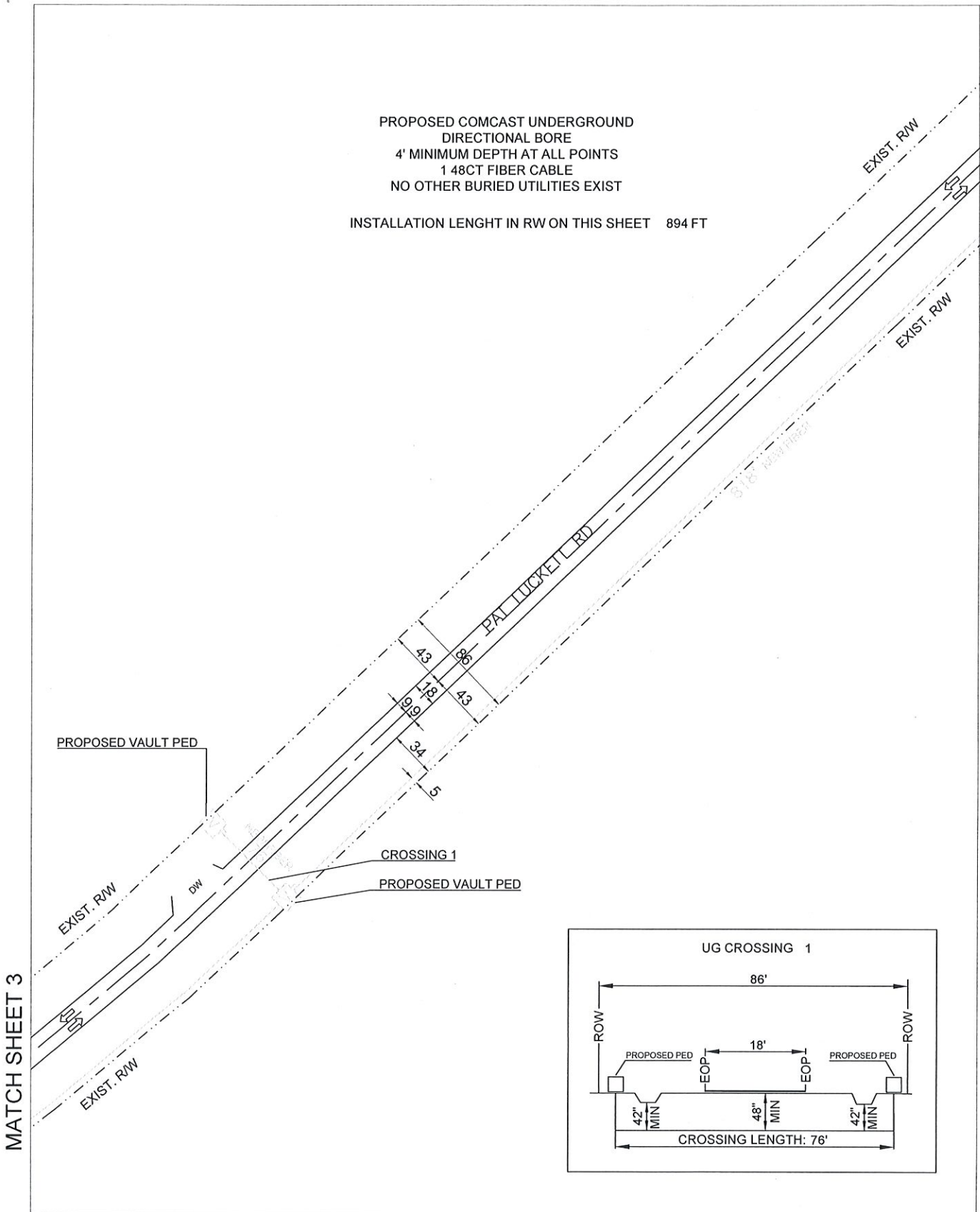

NO MATCH SHEET

<p>PREPARED BY:</p> <p>QUASAR, INC.</p>	<p>EXISTING POLE</p> <p>PROPOSED PEDESTAL</p> <p>PROPOSED VAULT</p> <p>WATER VALVE</p> <p>FIBER MARKER</p> <p>GAS MARKER</p> <p>MANHOLE</p> <p>SEWER MANHOLE</p> <p>STORM DRAIN</p>	<p>RIGHT OF WAY LINE</p> <p>IRRIGATION LINE</p> <p>WATER LANE</p> <p>GAS LANE</p> <p>PROPOSED ANCHOR</p> <p>PROPOSED RISER</p>	<p>PROPOSED COAXIAL CABLE</p> <p>PROPOSED FIBER CABLE</p> <p>PROPOSED DIRECTIONAL BORE</p> <p>EXISTING CABLE</p>		<p>ENGINEERED FOR:</p> <p>MADISON COUNTY</p> <p>PAT LUCKETT RD</p> <p>TRANSPORT FIBER</p>
	<p>LEGEND:</p> <p>RW - RIGHT OF WAY</p> <p>EOP - EDGE OF PAVEMENT</p> <p>DW - DRIVEWAY</p> <p>PDW - PAVED DRIVEWAY</p>	<p>NOTES:</p> <p>BORE HOLE TO BE FILLED SAME DAY</p> <p>VAULT HOLE TO BE FILLED SAME DAY</p> <p>ALL HOLES TO BE TAMPED AND SCAFFED</p>			<p>NO SCALE</p> <p>SHEET 2 OF 13</p>



NO MATCH SHEET

PROPOSED COMCAST UNDERGROUND  
 DIRECTIONAL BORE  
 4' MINIMUM DEPTH AT ALL POINTS  
 1 48CT FIBER CABLE  
 NO OTHER BURIED UTILITIES EXIST

INSTALLATION LENGTH IN RW ON THIS SHEET 756 FT

NO MATCH SHEET

MATCH SHEET 2

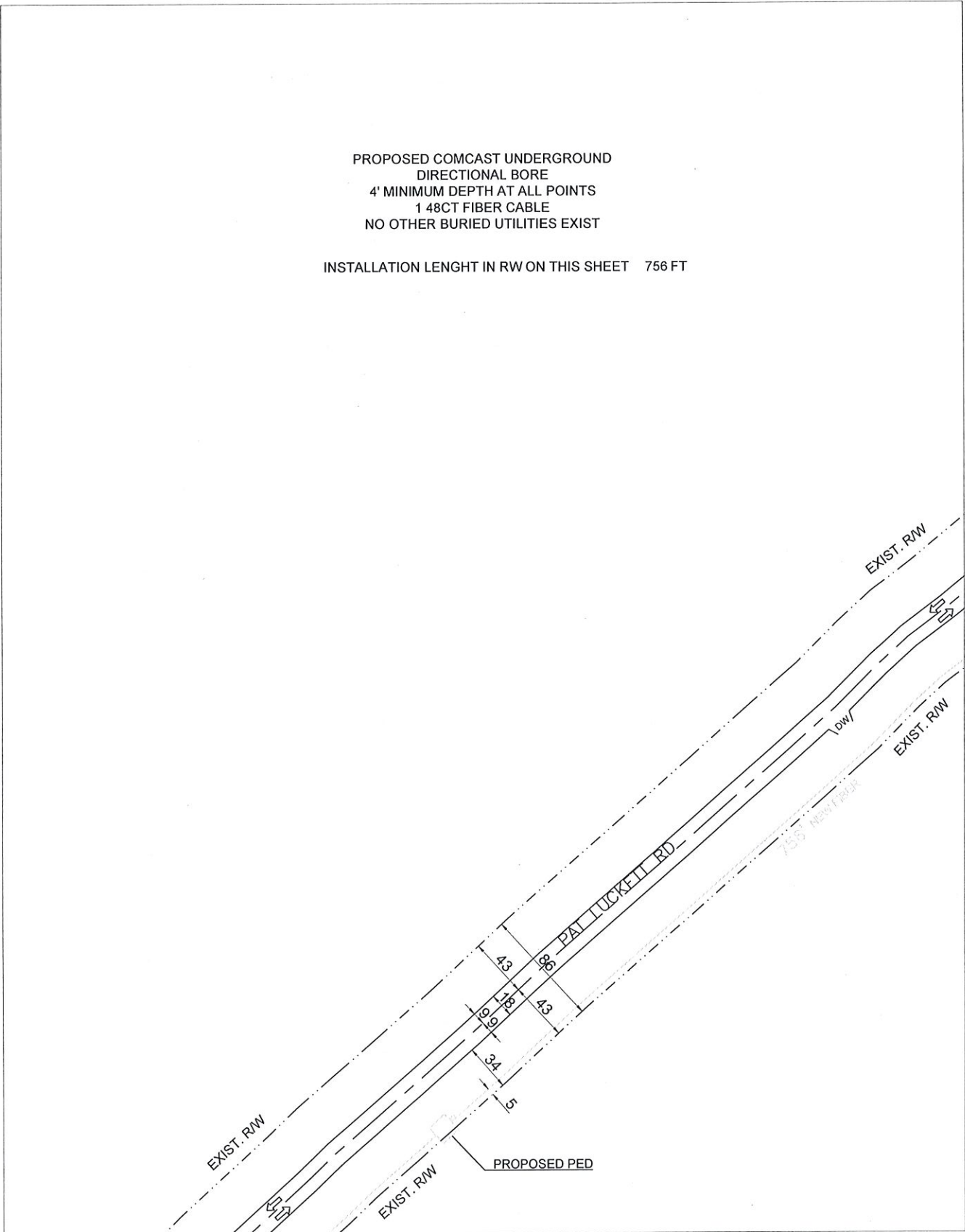

MATCH SHEET 4

PREPARED BY:  	EXISTING POLE PROPOSED PEDESTAL PROPOSED VAULT WATER VALVE FIBER MARKER GAS MARKER MANHOLE SEWER MANHOLE STORM DRAIN	RIGHT OF WAY LINE IRRIGATION LINE WATER LANE GAS LANE PROPOSED ANCHOR PROPOSED RISER	PROPOSED COAXIAL CABLE PROPOSED FIBER CABLE PROPOSED DIRECTIONAL BORE EXISTING CABLE		ENGINEERED FOR:  	MADISON COUNTY  PAT LUCKETTI RD  TRANSPORT FIBER
	LEGEND: RW - RIGHT OF WAY EOP - EDGE OF PAVEMENT DW - DRIVEWAY PDW - PAVED DRIVEWAY	NOTES: BORE HOLE TO BE FILLED SAME DAY VAULT HOLE TO BE FILLED SAME DAY ALL HOLE TO BE TAMPED AND SODDED	NO SCALE SHEET 3 OF 13			

PROPOSED COMCAST UNDERGROUND  
 DIRECTIONAL BORE  
 4' MINIMUM DEPTH AT ALL POINTS  
 1 48CT FIBER CABLE  
 NO OTHER BURIED UTILITIES EXIST

INSTALLATION LENGHT IN RW ON THIS SHEET 860 FT

MATCH SHEET 5

NO MATCH SHEET

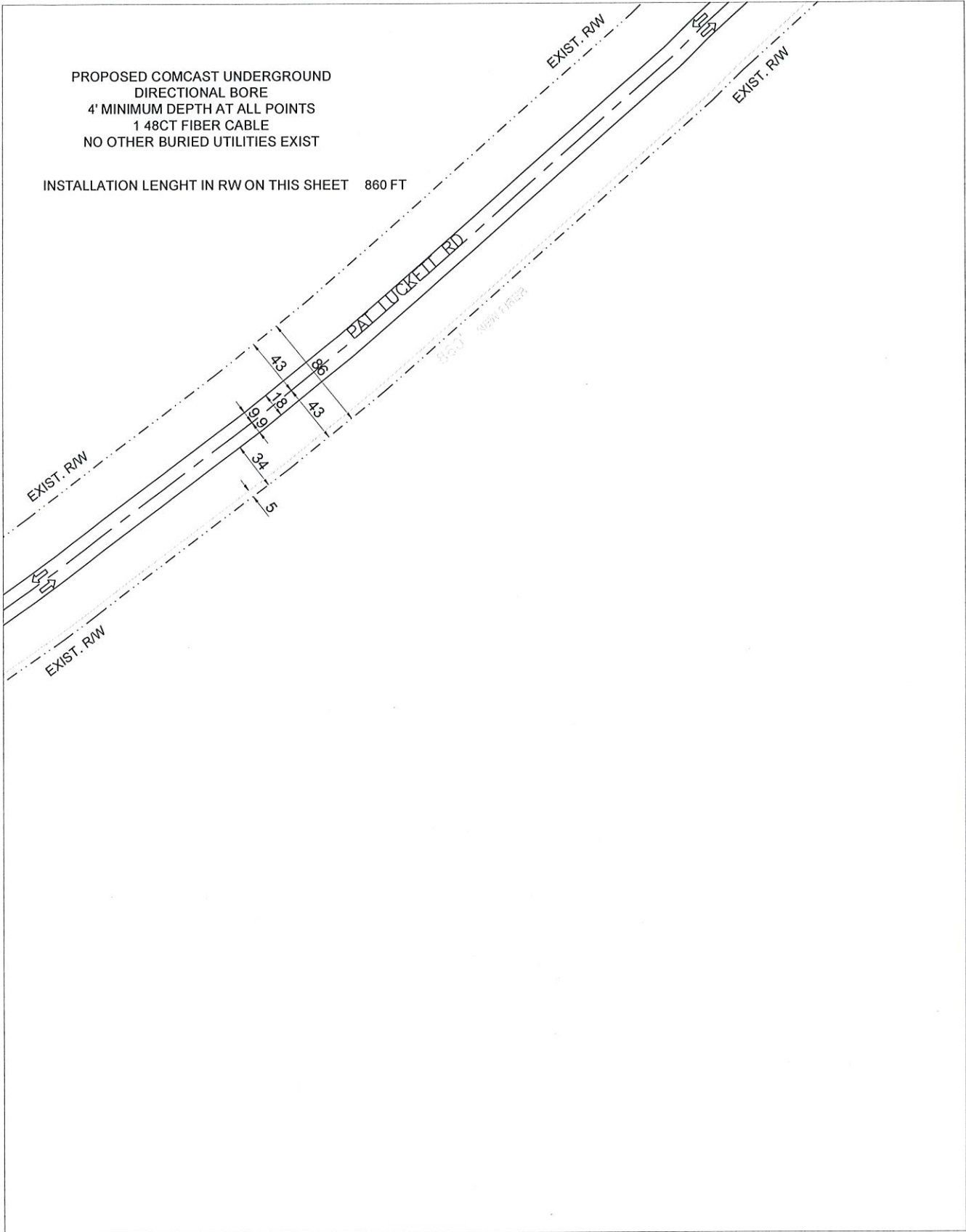

NO MATCH SHEET

PREPARED BY:  	EXISTING POLE PROPOSED PEDESTAL PROPOSED VAULT WATER VALVE FIBER MARKER GAS MARKER MANHOLE SEWER MANHOLE STORM DRAIN	RIGHT OF WAY LINE IRRIGATION LINE WATER LANE GAS LANE PROPOSED ANCHOR PROPOSED RISER	PROPOSED COAXIAL CABLE PROPOSED FIBER CABLE PROPOSED DIRECTIONAL BORE EXISTING CABLE		ENGINEERED FOR:  	MADISON COUNTY  PAT LUCKETT RD TRANSPORT FIBER
	LEGEND: RW - RIGHT OF WAY EOP - EDGE OF PAVEMENT DW - DRIVEWAY PDW - PAVED DRIVEWAY	NOTES: BORE HOLE TO BE FILLED SAME DAY VAULT HOLE TO BE FILLED SAME DAY ALL HOLE TO BE TAMPED AND SODDED	NO SCALE SHEET 4 OF 13			

NO MATCH SHEET

PROPOSED COMCAST NEW ATTACHMENT  
 18' MINIMUM HEIGHT AT ALL POINTS  
 1 48CT FIBER CABLE

PROPOSED COMCAST UNDERGROUND  
 DIRECTIONAL BORE  
 4' MINIMUM DEPTH AT ALL POINTS  
 1 48CT FIBER CABLE  
 NO OTHER BURIED UTILITIES EXIST

INSTALLATION LENGTH IN RW ON THIS SHEET 940 FT

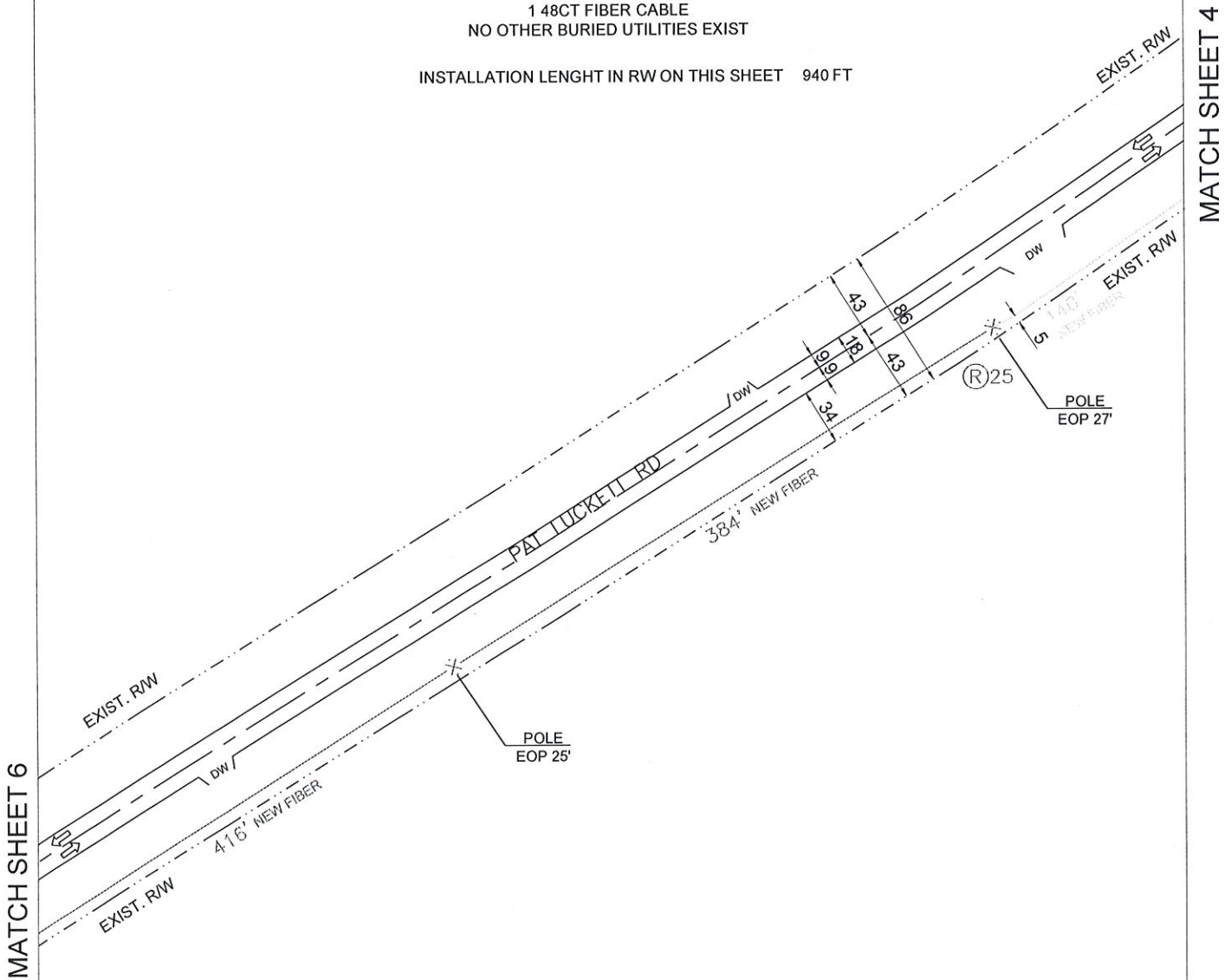

MATCH SHEET 6

MATCH SHEET 4

NO MATCH SHEET

PREPARED BY:  	EXISTING POLE PROPOSED PEDESTAL PROPOSED VAULT WATER VALVE FIBER MARKER GAS MARKER MANHOLE SEWER MANHOLE STORM DRAIN	RIGHT OF WAY LINE IRRIGATION LINE WATER LAINE GAS LAINE PROPOSED ANCHOR PROPOSED RISER	PROPOSED COAXIAL CABLE PROPOSED FIBER CABLE PROPOSED DIRECTIONAL BORE EXISTING CABLE		ENGINEERED FOR:  	MADISON COUNTY  PAT LOCKETT RD  TRANSPORT FIBER
	LEGEND: RW - RIGHT OF WAY EOP - EDGE OF PAVEMENT DW - DRIVEWAY PDW - PAVED DRIVEWAY	NOTES: BORE HOLE TO BE FILLED SAME DAY VAULT HOLE TO BE FILLED SAME DAY ALL HOLE TO BE TAMPED AND SODDED	NO SCALE		SHEET 5 OF 13	

NO MATCH SHEET

PROPOSED COMCAST NEW ATTACHMENT  
 18' MINIMUM HEIGHT AT ALL POINTS  
 1 48CT FIBER CABLE

INSTALLATION LENGTH IN RW ON THIS SHEET 893 FT

NO MATCH SHEET

MATCH SHEET 7

MATCH SHEET 5

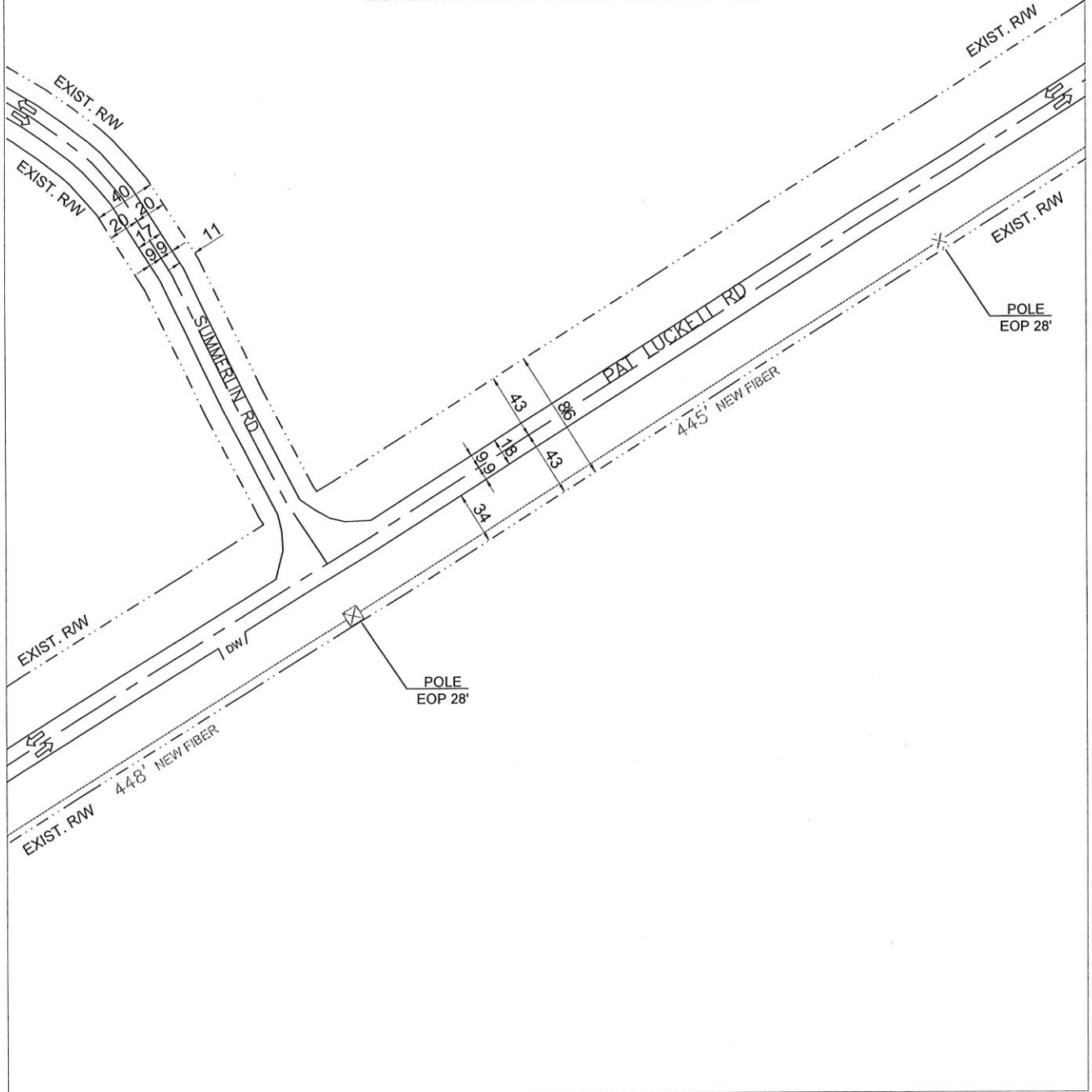

NO MATCH SHEET

PREPARED BY:  	EXISTING POLE PROPOSED PEDESTAL PROPOSED VAULT WATER VALVE FIBER MARKER GAS MARKER MANHOLE SEWER MANHOLE STORM DRAIN	RIGHT OF WAY LINE IRRIGATION LINE WATER LANE GAS LANE PROPOSED ANCHOR PROPOSED RISER	PROPOSED COAXIAL CABLE PROPOSED FIBER CABLE PROPOSED DIRECTIONAL BORE EXISTING CABLE		ENGINEERED FOR:  	MADISON COUNTY  PAT LUCKETT RD TRANSPORT FIBER
	LEGEND: RW - RIGHT OF WAY EOP - EDGE OF PAVEMENT DW - DRIVEWAY PDW - PAVED DRIVEWAY	NOTES: BORE HOLE TO BE FILLED SAME DAY VAULT HOLE TO BE FILLED SAME DAY ALL HOLE TO BE TAMPED AND SODDED	NO SCALE		SHEET 6 OF 13	

NO MATCH SHEET

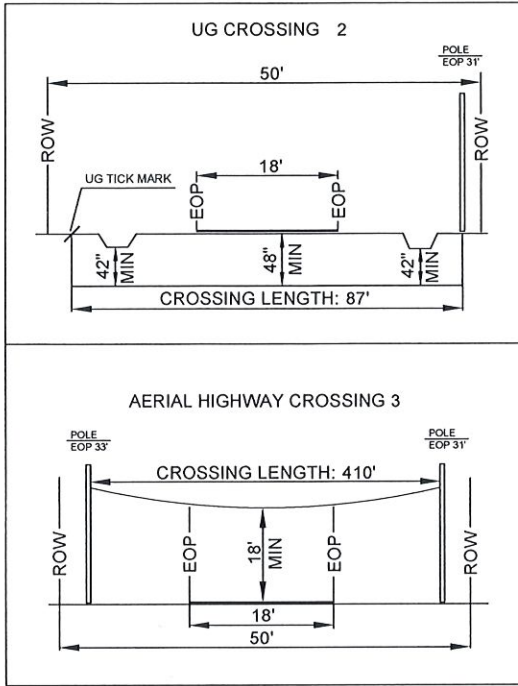

PROPOSED COMCAST NEW ATTACHMENT  
 18' MINIMUM HEIGHT AT ALL POINTS  
 1 48CT FIBER CABLE  
 1 24CT FIBER CABLE

PROPOSED COMCAST UNDERGROUND  
 DIRECTIONAL BORE  
 4' MINIMUM DEPTH AT ALL POINTS  
 1 24CT FIBER CABLE  
 NO OTHER BURIED UTILITIES EXIST

INSTALLATION LENGTH IN RW ON THIS SHEET 530 FT

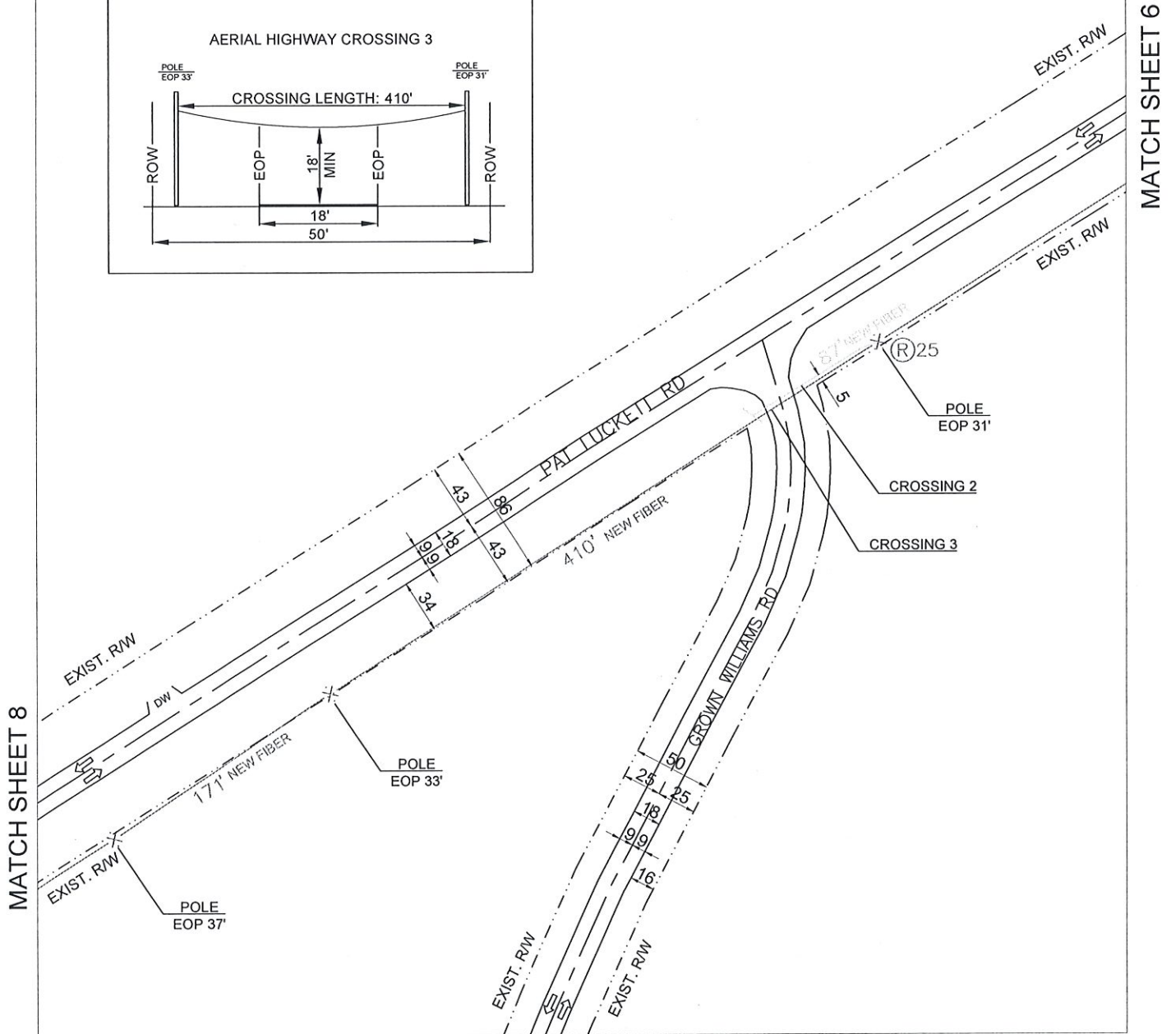

NO MATCH SHEET

PREPARED BY:  	EXISTING POLE PROPOSED PEDESTAL PROPOSED VAULT WATER VALVE FIBER MARKER GAS MARKER MANHOLE SEWER MANHOLE STORM DRAIN	RIGHT OF WAY LINE IRRIGATION LINE WATER LANE GAS LANE PROPOSED ANCHOR PROPOSED RISER	PROPOSED COAXIAL CABLE PROPOSED FIBER CABLE PROPOSED DIRECTIONAL BORE EXISTING CABLE		ENGINEERED FOR:  	MADISON COUNTY  PAT LUCKETT RD. GROWN WILLIAMS RD TRANSPORT FIBER
	LEGEND: RW - RIGHT OF WAY EOP - EDGE OF PAVEMENT DW - DRIVEWAY PDW - PAVED DRIVEWAY	NOTES: BORE HOLE TO BE FILLED SAME DAY VAULT HOLE TO BE FILLED SAME DAY ALL HOLE TO BE TAMPED AND SOODED	NO SCALE		SHEET 7 OF 13	

NO MATCH SHEET

PROPOSED COMCAST NEW ATTACHMENT  
 18' MINIMUM HEIGHT AT ALL POINTS  
 1 24CT FIBER CABLE

PROPOSED COMCAST UNDERGROUND  
 DIRECTIONAL BORE  
 4' MINIMUM DEPTH AT ALL POINTS  
 1 24CT FIBER CABLE  
 NO OTHER BURIED UTILITIES EXIST

INSTALLATION LENGTH IN RW ON THIS SHEET 863 FT

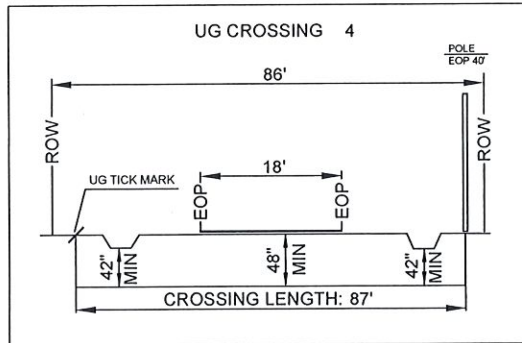
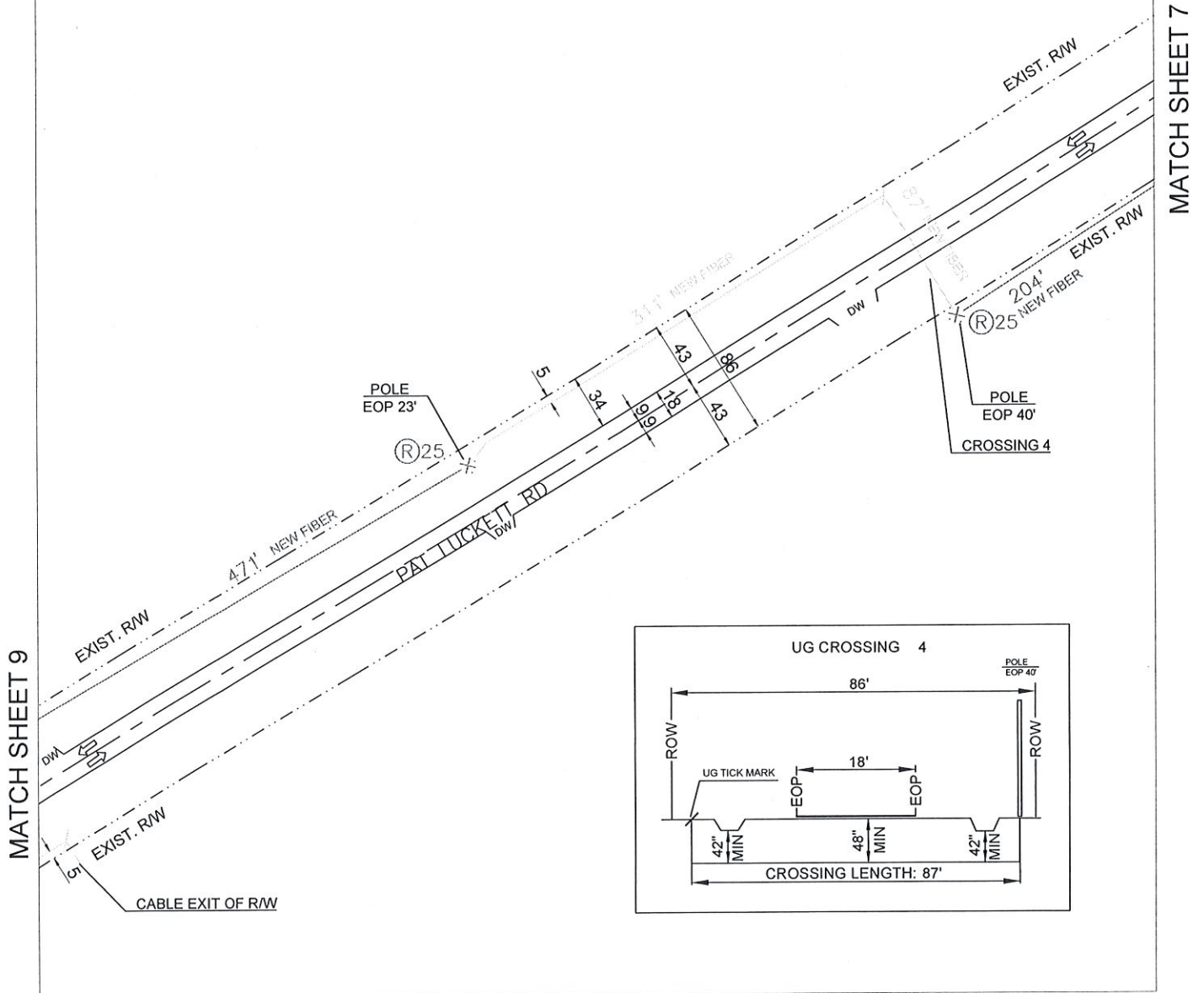

NO MATCH SHEET

PREPARED BY:  	EXISTING POLE PROPOSED PEDESTAL PROPOSED VAULT WATER VALVE FIBER MARKER GAS MARKER MANHOLE SEWER MAINHOLE STORM DRAIN	RIGHT OF WAY LINE IRRIGATION LINE WATER LAINE GAS LAINE PROPOSED ANCHOR PROPOSED RISER	PROPOSED COAXIAL CABLE PROPOSED FIBER CABLE PROPOSED DIRECTIONAL BORE EXISTING CABLE		ENGINEERED FOR: MADISON COUNTY PAT LUCKETT RD TRANSPORT FIBER
	LEGEND: RW - RIGHT OF WAY EOP - EDGE OF PAVEMENT DW - DRIVEWAY PDW - PAVED DRIVEWAY	NOTES: BORE HOLE TO BE FILLED SAME DAY VAULT HOLE TO BE FILLED SAME DAY ALL HOLE TO BE TAMPED AND SOODED			NO SCALE SHEET 8 OF 13

NO MATCH SHEET

PROPOSED COMCAST NEW ATTACHMENT  
 18' MINIMUM HEIGHT AT ALL POINTS  
 1 24CT FIBER CABLE

PROPOSED COMCAST UNDERGROUND  
 DIRECTIONAL BORE  
 4' MINIMUM DEPTH AT ALL POINTS  
 1 24CT FIBER CABLE  
 NO OTHER BURIED UTILITIES EXIST

INSTALLATION LENGTH IN RW ON THIS SHEET 576 FT

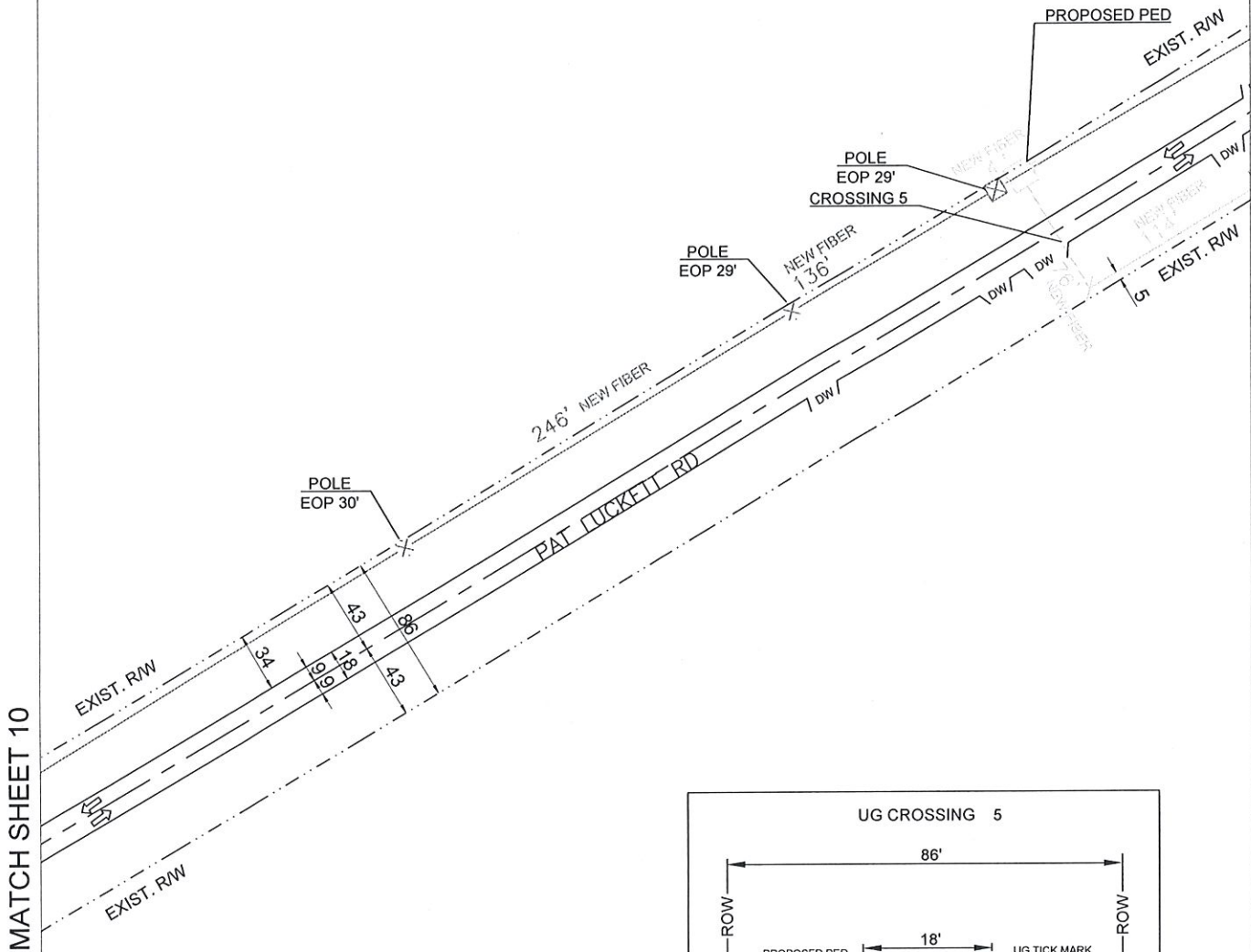

MATCH SHEET 10

MATCH SHEET 8

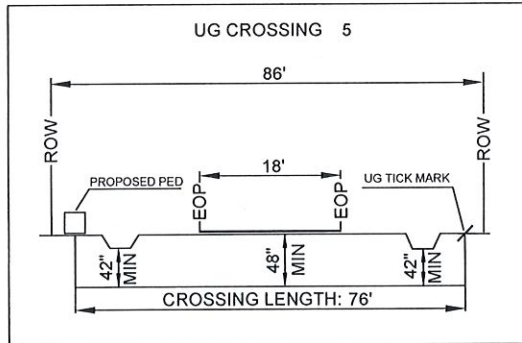

NO MATCH SHEET

PREPARED BY:  	EXISTING POLE PROPOSED PEDESTAL PROPOSED VAULT WATER VALVE FIBER MARKER GAS MARKER MANHOLE SEWER MANHOLE STORM DRAIN	RIGHT OF WAY LINE IRRIGATION LINE WATER LAINE GAS LAINE PROPOSED ANCHOR PROPOSED RISER	PROPOSED COAXIAL CABLE PROPOSED FIBER CABLE PROPOSED DIRECTIONAL BORE EXISTING CABLE		ENGINEERED FOR:  	MADISON COUNTY  PAT LUCKETT RD TRANSPORT FIBER
	LEGEND: RW - RIGHT OF WAY EOP - EDGE OF PAVEMENT DW - DRIVEWAY PDW - PAVED DRIVEWAY	NOTES: BORE HOLE TO BE FILLED SAME DAY VAULT HOLE TO BE FILLED SAME DAY ALL HOLE TO BE TAMPED AND SODDED	NO SCALE		SHEET 9 OF 13	

NO MATCH SHEET

PROPOSED COMCAST NEW ATTACHMENT  
 18' MINIMUM HEIGHT AT ALL POINTS  
 1 24CT FIBER CABLE

PROPOSED COMCAST UNDERGROUND  
 DIRECTIONAL BORE  
 4' MINIMUM DEPTH AT ALL POINTS  
 1 24CT FIBER CABLE  
 NO OTHER BURIED UTILITIES EXIST

INSTALLATION LENGTH IN RW ON THIS SHEET 1172 FT

NO MATCH SHEET

MATCH SHEET 9

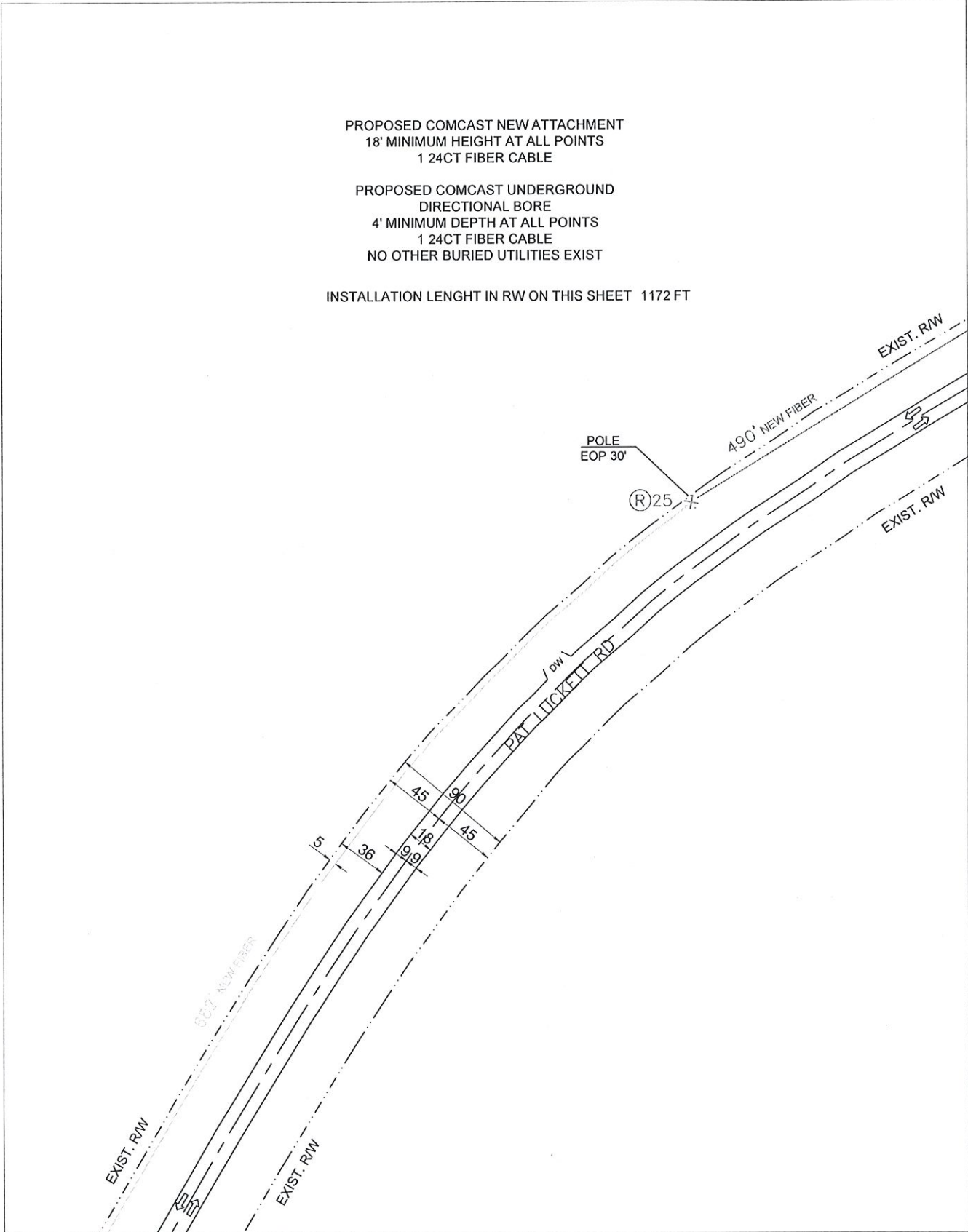

MATCH SHEET 11

PREPARED BY:  	EXISTING POLE PROPOSED PEDESTAL PROPOSED VAULT WATER VALVE FIBER MARKER GAS MARKER MANHOLE SEWER MANHOLE STORM DRAIN	RIGHT OF WAY LINE IRRIGATION LINE WATER LANE GAS LANE PROPOSED ANCHOR PROPOSED RISER	PROPOSED COAXIAL CABLE PROPOSED FIBER CABLE PROPOSED DIRECTIONAL BORE EXISTING CABLE		ENGINEERED FOR: MADISON COUNTY PAT LOCKETT RD TRANSPORT FIBER		NO SCALE	SHEET 10 OF 13
	LEGEND: RW - RIGHT OF WAY EOP - EDGE OF PAVEMENT DW - DRIVEWAY PDW - PAVED DRIVEWAY	NOTES: BORE HOLE TO BE FILLED SAME DAY VAULT HOLE TO BE FILLED SAME DAY ALL HOLE TO BE TAMPED AND SODDED						



PROPOSED COMCAST UNDERGROUND  
 DIRECTIONAL BORE  
 4' MINIMUM DEPTH AT ALL POINTS  
 1 24CT FIBER CABLE  
 NO OTHER BURIED UTILITIES EXIST



INSTALLATION LENGTH IN RW ON THIS SHEET 787 FT

PROPOSED PED

MATCH SHEET 12

NO MATCH SHEET

NO MATCH SHEET

PREPARED BY:   QUASAR, INC.	EXISTING POLE PROPOSED PEDESTAL PROPOSED VAULT WATER VALVE FIBER MARKER GAS MARKER MANHOLE SEWER MAINHOLE STORM DRAIN	RIGHT OF WAY LINE IRRIGATION LINE WATER LAINE GAS LAINE PROPOSED ANCHOR PROPOSED RISER	PROPOSED COAXIAL CABLE PROPOSED FIBER CABLE PROPOSED DIRECTIONAL BORE EXISTING CABLE		ENGINEERED FOR:   COMCAST	MADISON COUNTY  PAT LUCKETT RD  TRANSPORT FIBER
	LEGEND: RW - RIGHT OF WAY EOP - EDGE OF PAVEMENT DW - DRIVEWAY PDW - PAVED DRIVEWAY	NOTES: BORE HOLE TO BE FILLED SAME DAY VAULT HOLE TO BE FILLED SAME DAY ALL HOLE TO BE TAMPED AND SODDED	NO SCALE		SHEET 11 OF 13	

NO MATCH SHEET

PROPOSED COMCAST NEW ATTACHMENT  
 18' MINIMUM HEIGHT AT ALL POINTS  
 1 24CT FIBER CABLE

PROPOSED COMCAST UNDERGROUND  
 DIRECTIONAL BORE  
 4' MINIMUM DEPTH AT ALL POINTS  
 1 24CT FIBER CABLE  
 NO OTHER BURIED UTILITIES EXIST

INSTALLATION LENGTH IN RW ON THIS SHEET 1081 FT

NO MATCH SHEET

MATCH SHEET 11

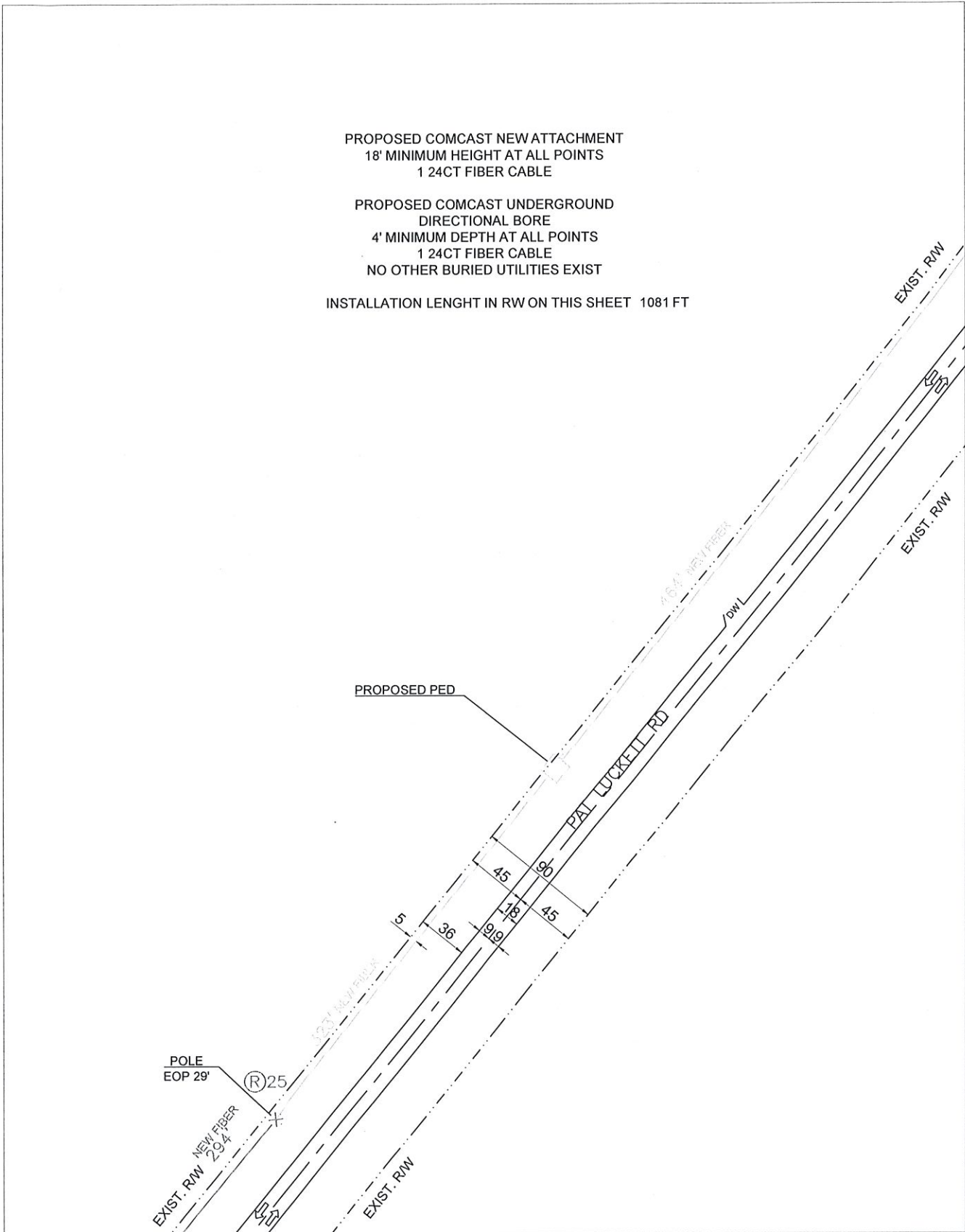

MATCH SHEET 13

PREPARED BY:  	EXISTING POLE PROPOSED PEDESTAL PROPOSED VAULT WATER VALVE FIBER MARKER GAS MARKER MANHOLE SEWER MANHOLE STORM DRAIN	RIGHT OF WAY LINE IRRIGATION LINE WATER LANE GAS LANE PROPOSED ANCHOR PROPOSED RISER	PROPOSED COAXIAL CABLE PROPOSED FIBER CABLE PROPOSED DIRECTIONAL BORE EXISTING CABLE		ENGINEERED FOR: MADISON COUNTY PAT LOCKETT RD TRANSPORT FIBER
	LEGEND: RW - RIGHT OF WAY EOP - EDGE OF PAVEMENT DW - DRIVEWAY PDW - PAVED DRIVEWAY	NOTES: BORE HOLE TO BE FILLED SAME DAY VAULT HOLE TO BE FILLED SAME DAY ALL HOLE TO BE TAMPED AND SOODED			NO SCALE SHEET 12 OF 13

PROPOSED COMCAST NEW ATTACHMENT  
 18' MINIMUM HEIGHT AT ALL POINTS  
 1 24CT FIBER CABLE

INSTALLATION LENGHT IN RW ON THIS SHEET 533 FT  
 TOTAL INSTALLATION LENGHT 10438 FT  
 AERIAL: 4306 FT  
 UG: 6132 FT  
 START 32.670399, -89.767953  
 END 32.653022, -89.793853

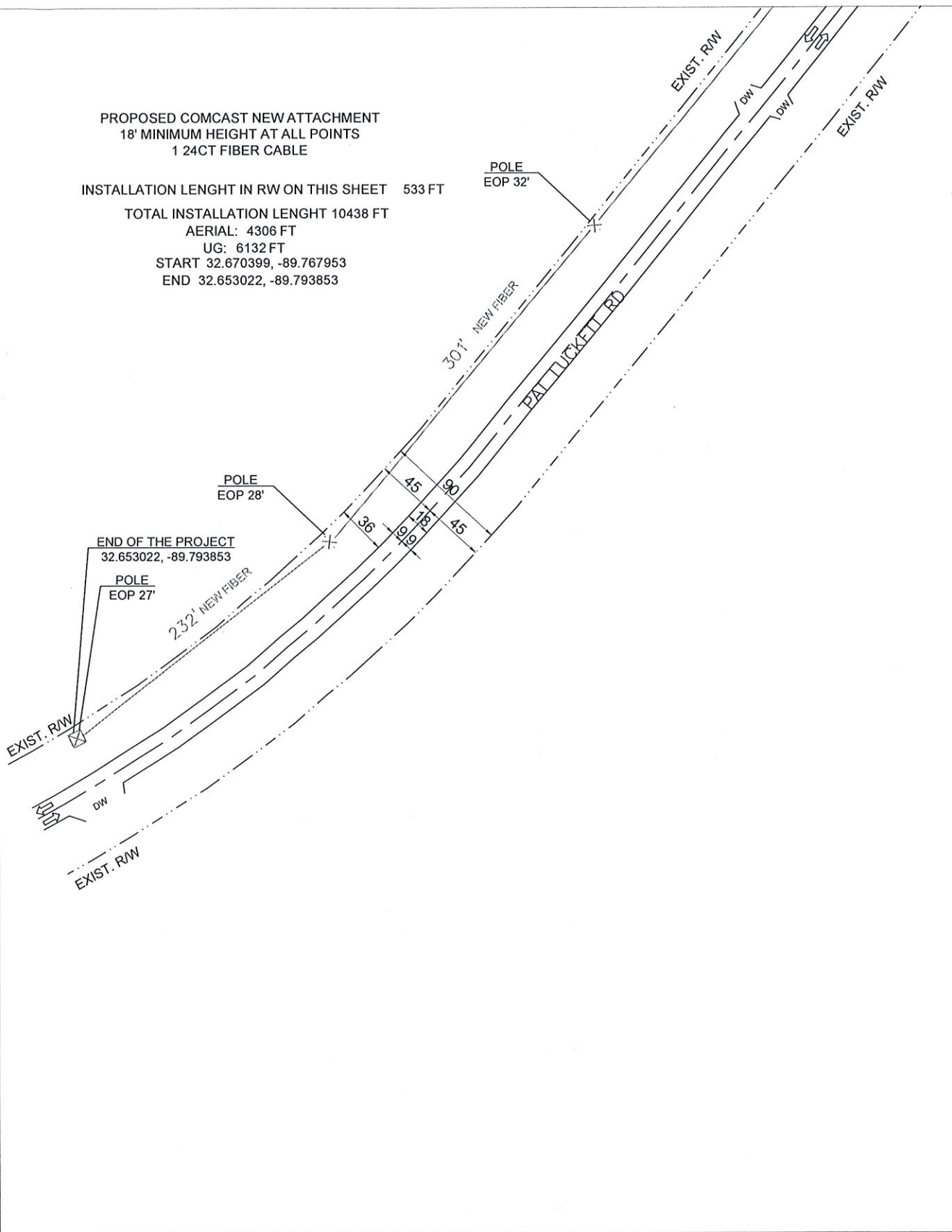

NO MATCH SHEET

NO MATCH SHEET

NO MATCH SHEET

PREPARED BY:  	EXISTING POLE PROPOSED PEDESTAL PROPOSED VAULT WATER VALVE FIBER MARKER GAS MARKER MANHOLE SEWER MANHOLE STORM DRAIN	RIGHT OF WAY LINE IRRIGATION LINE WATER LANE GAS LANE PROPOSED ANCHOR PROPOSED RISER	PROPOSED COAXIAL CABLE PROPOSED FIBER CABLE PROPOSED DIRECTIONAL BORE EXISTING CABLE		ENGINEERED FOR:  	MADISON COUNTY  PAT LOCKETT RD  TRANSPORT FIBER
	LEGEND: RW - RIGHT OF WAY EOP - EDGE OF PAVEMENT DW - DRIVEWAY PDW - PAVED DRIVEWAY	NOTES: BORE HOLE TO BE FILLED SAME DAY VAULT HOLE TO BE FILLED SAME DAY ALL HOLE TO BE TAMPED AND SODDED	NO SCALE SHEET 13 OF 13			